

# SIMULATION OF A VEHICLE IN LONGITUDINAL MOTION WITH CLUTCH LOCK AND CLUTCH RELEASE

Lars Eriksson

*Vehicular Systems, Linköping University, SE-581 83 Linköping  
Tel: +46-13-28 44 09, Fax:+46-13-28 20 35  
E-mail: larer@isy.liu.se*

Abstract: A simple model for driver and vehicle in longitudinal motion is developed and simulated. The focus is on describing and handling simulation of clutch lock and clutch release which changes the model structure, both during start and gear shifts, in Simulink. Special attention is given the problem of simulating start and stop of a vehicle with rolling resistance at zero speed. Only principles for simulating the system with variable structure is of interest and therefore the models are maintained at lowest possible complexity. The system is successfully simulated and the validation is performed using three scenarios: one with only clutch lock and clutch release, one with start and stop of vehicle, and one full European drive-cycle.

Keywords: Driveline, transmission, friction, rolling resistance.

## 1. INTRODUCTION

Simulation of complete vehicles with engine and driveline is an important tool, for example when investigating how different driveline configurations effect the fuel consumption and emissions in a driving cycle. A vehicle contains many components and the purpose of the study dictates what components must be included as well as the level of detail of the components. The clutch connects two masses to each other and introduces intricate difficulties when simulating the clutch connect and release as the structure of the system changes. Emphasis is on isolating and describing the simulation problems in an introductory manner such that students easily can understand the difficulties when simulating a system with changing structure.

Two issues that pose problems in simulation are addressed. First, when the clutch is separated the system has two degrees of freedom, which in the simulation is represented by two states. When the clutch is locked then the two masses are locked

together and the system has only one degree of freedom. Thus at the instant when the clutch locks the system changes structure as one state disappears and likewise when the clutch unlocks when one state appears. Another issue is the rolling resistance at zero velocity, i.e. the torque needed to start moving the vehicle from zero. This is further described in Section 3. Both these problems have been addressed by many authors and the solutions proposed here are not new. The focus here is to develop simple models that isolates the simulation difficulties and are well suited for educational purposes. In addition the presentation address both issues and solves them such that the model can be simulated in the readily available tool Simulink (Mat 1999).

The aim here is to simulate the clutch lock and release as well as the rolling of the vehicle without losing the perspective due to a too complex total model. Therefore simple models, that capture the behavior without hiding them in details, are developed for the different vehicle subsystems shown in Figure 1.

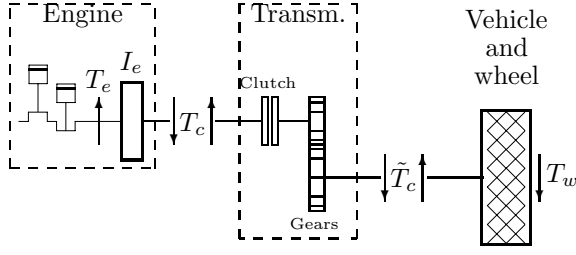

Fig. 1. Sketch of a vehicle consisting of engine, transmission, and vehicle body. The transmission includes clutch, gear box, and final drive. The arrows indicate the sign convention: up=driving torque, down=load torque.

## 2. TRANSMISSION MODEL

First the clutch model is described in isolation to show how clutch lock and clutch release is determined. Then the gearbox and final drive are added and the algebraic transformations over a set of gears are shown. Finally an illustrative simulation validates that the model works properly.

### 2.1 Friction Clutch

Three basic assumptions are made, the friction clutch is: inelastic, mass less, and there are no friction losses (except the obvious between the plates). To describe the clutch behaviour it is necessary to connect it to two rotating masses with inertias  $I_e$  and  $I_v$ , corresponding to the engine side and the vehicle side respectively. A torque  $T_e$  is driving the system and a torque  $T_v$  is braking the system, see Figure 2.

The clutch pedal position  $u_c$  is connected to the clutch discs and produces a force that presses the clutch discs together,  $F_c(u_c)$ . Here  $u_c(t) \in [0, 1]$  and 0 means separated clutch and 1 means full force on the clutch discs. This force influences the maximum torque that the clutch can transfer  $T_{c,k}(F_c(u_c(t)))$ . Here a simple linear model from the input  $u_c$  is used

$$T_{c,k}(F_c(u_c(t))) = T_{max,k} * u_c(t) \quad (1)$$

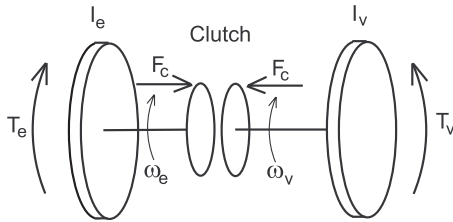

Fig. 2. Sketch of the clutch that shows the sign conventions of the applied torques and velocities.  $T_e$  is the driving torque from the engine side and  $T_v$  is the load torque on the vehicle side. Clutch torque,  $T_c$  is not shown but the sign convention is that it loads the engine inertia and drives the vehicle inertia.

In the expression above the kinetic friction  $T_{c,k}$  is modeled, i.e. the clutch torque when the clutch disks are slipping. However, when the clutch is locked the clutch can transfer a higher (static) torque. The quotient between the static and dynamic friction is modeled as a constant, where

$$\frac{T_{c,s}(t)}{T_{c,k}(t)} = c_{s,k} > 1 \quad (2)$$

The maximum static friction torque is thus

$$T_{c,s}(F_c(u_c(t))) = T_{max,k} c_{s,k} u_c(t) \quad (3)$$

The clutch and the surrounding system have two important system states and two important events for the transition between them.

**S1 - Two mass system:** The system has two masses that rotate with speeds independent of each other but their respective movements are connected to each other through to the transferred clutch torque. In this state the systems surrounding the clutch have two degrees of freedom and the equations that govern their rotations are

$$\begin{aligned} I_e \frac{d\omega_e}{dt} &= T_e - T_c \\ I_v \frac{d\omega_v}{dt} &= T_c - T_v \end{aligned}$$

The torque transferred through the clutch is

$$T_c = T_{c,k}(f_c(u_c)) \operatorname{sgn}(\omega_e - \omega_v)$$

where  $\operatorname{sgn}$  is the signum function. The equations above are valid when  $\omega_v \neq \omega_e$ .

**S2 - One mass system:** The clutch disc locks the two rotating systems to each other and the two masses rotate with identical speed. Under these conditions the rotation of the surrounding two masses have only one degree of freedom and the equations that govern the rotations are

$$\begin{aligned} (I_e + I_v) \frac{d\omega_e}{dt} &= T_e - T_v \\ \omega_v &= \omega_e \end{aligned} \quad (4)$$

When the clutch is locked the torque transferred in the clutch  $T_{c,l}$  depends on the applied torques and the inertias. The transferred torque is the driving torque minus the inertia effect of the first mass

$$T_{c,l} = T_e - I_e \frac{d\omega_e}{dt}$$

Inserting Equation 4 and manipulating gives the clutch torque

$$T_{c,l} = \frac{T_e I_v + T_v I_e}{I_e + I_v} \quad (5)$$

**E1 - Clutch lock:** The instant when the clutch locks the two rotating systems to each other. Prior to the lock event the two systems rotate freely other and two conditions must be fulfilled for the clutch to lock:

- (1) The angular velocities must match  $\omega_v = \omega_e$ .

- (2) The torque that the clutch transfers under locked conditions, Equation 5, must be less or equal to the maximum possible static friction, Equation 3. I.e the following equation that must be fulfilled  $T_{c,l} \leq T_{c,s}$ .

By continuously monitoring these conditions the instant when the clutch locks can be determined. In the Simulink implementation the first condition is checked using a hit crossing block which forces the simulation to detect the instant when the velocities match. If condition 2) is also fulfilled at that instant then the clutch is locked and the system is set to state S2.

**E2 - Clutch breakup:** The condition for determining the clutch breakup is when the torque that the clutch transfers under locked condition exceeds the maximum for the static friction torque in the clutch

$$T_{c,l} > T_{c,s}$$

This causes the clutch to start slipping and the two masses start rotating with differing speeds. In the simulation a new state must be initialized using the relation  $\omega_e = \omega_v$ .

## 2.2 Gear box and final drive

The gear box and final drive are modeled as rigid, friction free, and mass less elements that are lumped together into one set of gears, see Figure 1. The cogwheels in the transmission change the torque and rotational speed. The gear ratio  $i_g$  connects the incoming and outgoing rotational velocities and torques

$$i_g = \omega_v/\omega_w, \quad i_g = T_w/T_v \quad (6)$$

where subscript  $v$  corresponds to the side connected to the clutch and  $w$  the wheel side. A mass with inertia  $I_w$  connected to the wheel side of the gears can be transferred to an *equivalent inertia* at the clutch side through

$$I_v = I_w/i_g^2 \quad (7)$$

Using these transformations a rigid system with gears can be transformed into a system shown in Figure 2 and these equations can be used directly.

## 2.3 Simulink Implementation

The clutch and gearbox are implemented in Simulink (Mat 1999) using enabled subsystems with resettable integrators. One subsystem implements S1 and the other S2, control logic is implemented based on E1 and E2 that determine what subsystem to run. The wheel and engine speeds are selected as states in S1, which means that the clutch torque, inertia, and speeds are transformed

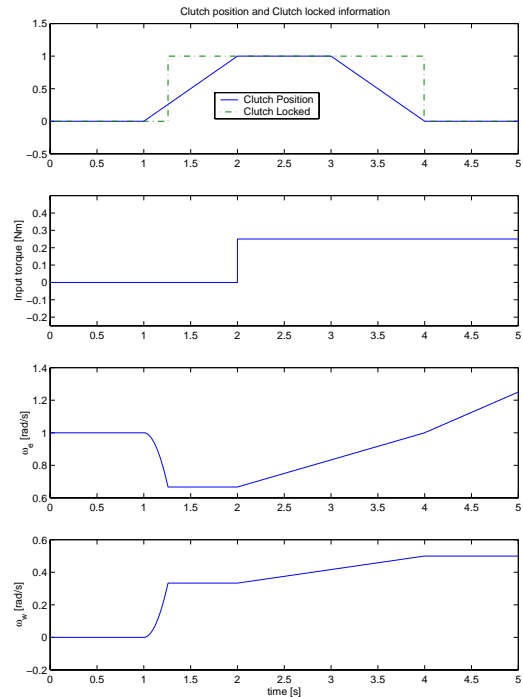

Fig. 3. Simulation of clutch lock and unlock a sequence of changes in the clutch control signal, and input torque.

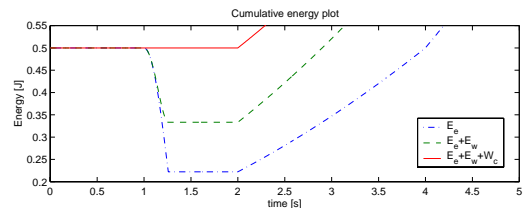

Fig. 4. Cumulative plot of energy stored in the masses and dissipated in the clutch for the simulation shown in Figure 3.

using (6) and (7). Wheel speed is selected as the only state in S2. A similar model of a clutch, but without gears, has previously been published in Mathworks Automotive Examples (Mat 1998). That model is freely available at Mathworks website and is well suited as a starting point. An important remark is that during the simulation it is important that the clutch is fully engaged  $u_c = 0$  when a change in gear ratio is made, otherwise Simulink might have difficulties simulating the system.

**2.3.1. Clutch Lock and Unlock – Simulation** A simple clutch lock and unlock simulation is used to validate that the clutch and gears are working properly, Figure 3. Two rotating masses without friction with  $I_e=1$  and  $I_w=2$  are connected to the transmission model with gear ratio is  $i_g=2$ . Initially  $I_e$  rotates at 1 rad/s and  $I_w$  does not move at all. The clutch signal is also zero. Between  $t=1$  s and 2 s  $u_c$  is ramped from 0 to 1 which result in a decrease in  $\omega_e$  and an increase in  $\omega_w$ . At

$t=1.25$  s,  $\omega_w * i_e$  equals  $\omega_e$  and the clutch locks. At  $t=2$  s an torque is applied on the engine side of the clutch and the system starts to accelerate. Between  $t=3$  s and 4 s the clutch is ramped from 1 to 0 and just before  $t=4$  s the clutch releases and  $I_w$  stops accelerating.

One important verification of the operation is to study the energy conservation, Figure 4. In the figure a cumulative plot of the energy, contained in and dissipated by the system, is plotted for the simulation shown in Figure 3. The lowest dash-dotted line shows the rotational energy in  $I_e$ ,  $E_e = \frac{I_e \omega_e^2}{2}$  when the clutch is engaged at  $t=1$  s energy is transferred to the second inertia and the middle line in the plot shows the sum  $E_e + E_w = \frac{I_e \omega_e^2}{2} + \frac{I_w \omega_w^2}{2}$ . The total rotational energy decreases when the clutch is engaged which is due to the energy dissipated in the friction clutch while the clutch locks. The work produced on the clutch disks is  $W_c = \int T_{c,k}(t) \Delta\omega(t) dt$ . The sum  $E_e + E_w + W_c$  is constant, 0.5 J, when no additional energy is put into the system. At  $t=2$  s the total energy starts to increase due to the added input torque. From this validation it can be concluded that the implemented clutch model is correct and that it conserves the energy.

### 3. VEHICLE MODEL

In this section a longitudinal vehicle model is lumped to an equivalent rotational model under the assumption of a rigid wheel that rolling without slipping. The forces acting on the vehicle is modeled using the standard models described in for example (Kiencke and Nielsen 2000). Forces on the vehicle that influence the motion are the sum of the driving force from the wheel  $F_f$  (which comes from friction between the wheel and ground), air drag  $F_a$ , and the gravitational force which together with Newton's second law yields

$$m \frac{dv}{dt} = F_f - (F_a + m g \sin(\alpha)) = F_f - F_w$$

where  $m$  is the vehicle mass, and  $\alpha$  is the slope of the road,  $g$  is the gravitation. The air drag is  $F_a = \frac{1}{2} c_w A \rho v^2$  where  $c_w$  is the air drag coefficient,  $A$  is the effective area,  $\rho$  the air density, and  $v$  the vehicle velocity. The wheel is considered to be rigid wheel slip slip is neglected and the wheel inertia is considered to be negligible in comparison to the vehicle mass. Under these conditions the following torque balance can be stated for the wheel

$$\tilde{T}_c - T_r - T_b = F_f r_w$$

where  $\tilde{T}_c$  is a driving torque that comes from the clutch via the gear box,  $T_b$  is the brake torque,  $r_w$  is the wheel radius, and  $T_r$  rolling resistance. The brake torque is modeled as a function of the

brake pedal position  $T_b = T_{b,max} u_b$   $u_b \in [0, 1]$ . The rolling resistance is modeled as a torque that opposes the wheel rotation, and a linear function of the rotational speed is used  $T_r = m(c_1 + c_v \omega)$ . See for example (Gillespie 1992) for a discussion of the model and the model parameters. In the following the influence of the gravitational force is omitted.

The vehicle mass  $m$  that has a translatory movement and is connected to a rotating system through a rigid wheel with radius  $r_w$  can be transformed into an *equivalent rotating inertia*

$$I_w = m \cdot r_w^2$$

The forces acting on the vehicle can likewise be transformed to torques that act on the equivalent rotating mass,  $T = F r_w$ . In the simulation implementation the state corresponding to the vehicle speed is the equivalent rotating velocity  $\omega_w = v/r_w$ .

**3.0.2. Lumped Model** The air drag and rolling resistance models are lumped together and parameterized using a second order polynomial in  $\omega_w$ .

$$T_{w,r} = c_0 + c_1 \omega_w + c_2 \omega_w^2$$

Where  $c_0$  to  $c_2$  are fitted to a specific vehicle configuration using the least squares method. Four points have been used to determine the maximum speed point and the three vehicle speeds 70, 90, and 110 km/h. There were no data available for velocities close to zero so the "dry friction" constant  $c_0$  is not accurately determined. However, the exact value of  $c_0$  is not important here since this is only a illustrative simulation study.

An important simulation aspect is how the torque  $T_w$  is handled when the vehicle is at rest but there is a torque driving it. This can be handled analogously to standard friction models, see e.g. (Olsson *et al.* 1998). When the vehicle is moving the torque  $T_w$  can be subtracted directly from the driving torque to get the angular acceleration but when the vehicle is standing still the dry friction and the braking torque,  $c_0 + T_b$  in the model for  $T_w$ , must be matched to the driving torque,  $\tilde{T}_c$ . This matching is necessary since the driving torque must overcome the dry friction in order to make the vehicle move. An incorrectly designed friction model can produce chattering in the vehicle speed. The implemented model is

$$T_w = \begin{cases} \min(\tilde{T}_c, c_0 + T_b) & \text{if } \omega_w = 0 \\ c_0 + c_1 \omega_w + c_2 \omega_w^2 + T_b & \text{otherwise} \end{cases}$$

The torque  $T_w$  is always applied such that it opposes the motion.

It is important to note one detail; The necessity for the wheel friction model to have information from the transmission about the driving torque

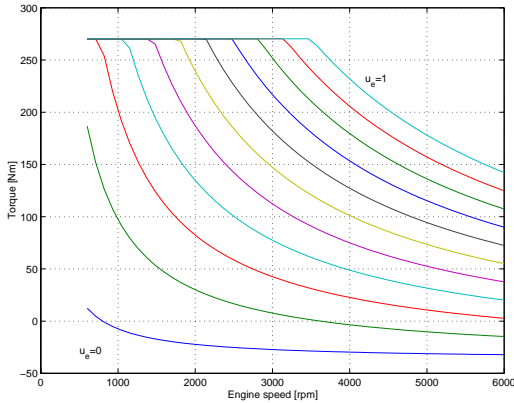

Fig. 5. A map of the engine torque  $T_{demand}(N, u_e)$ . The lines in the plot represent constant  $u_e$ . The idle speed is set to 800 RPM which is seen in the plot  $T_{demand}(800, 0) = 0$  Nm. The maximum torque is 280 Nm and the engine speed where T starts to decrease is 3500 RPM.

such that the rolling resistance torque  $T_w$  can be matched to the driving torque  $\tilde{T}_c$ .

#### 4. ENGINE MODEL

A physically justified engine model is used for the torque from spark ignited engines, see Figure 5 for the torque function. The engine torque is parameterized to capture the following features: 1) The maximum torque  $T_{e,max}$ . 2) The decrease in the torque curve at high speeds, which represents the choking of the engine. 3) Idling and idle speed control. 4) Engine braking at speeds over idling. The model is derived from an ideal thermodynamic cycle that includes pumping work but neglects residual gases. The basis for the parameterization is to determine a lowest air mass flow and a highest air mass flow and the gas pedal position gives a desired air mass flow in between these. From this a desired intake manifold pressure is determined using a model based on constant volumetric efficiency. The manifold pressure is then limited to atmospheric pressure. Finally an ideal Otto cycle with pumping work and friction is used to determine the output torque. The resulting torque model is shown in Figure 5 as a function of engine speed and control input  $u_e$ . The focus on air mass flow can be motivated since nowadays many engine management systems have drive-by-wire systems that implement air mass flow control instead of just throttle plate position control.

A torque developing engine dynamics is modeled using a first order system with a time constant of 0.1 s from the demanded torque.

$$T_e = \frac{1}{0.1s + 1} T_{demand}$$

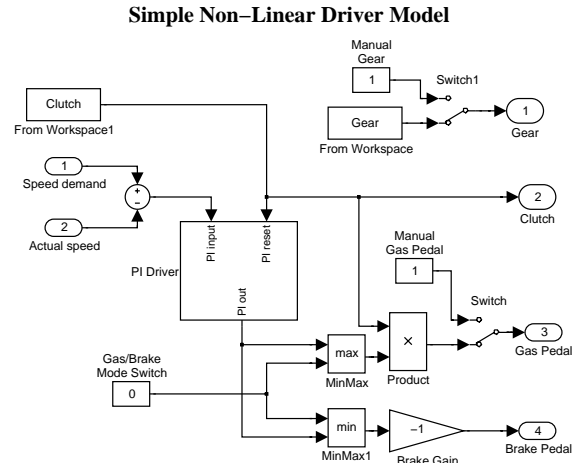

Fig. 6. Simulink implementation of a simple driver.

$T_{demand}$  is the non-linear function, shown in Figure 5, of the engine speed and the accelerator pedal signal,  $u_e \in [0, 1]$ , from the driver.

#### 5. DRIVER MODEL

The driver is provided with the following information: reference speed, measured vehicle speed, a clutch signal, and a gear signal. The driver is modeled using a PI controller with non-linear actions governed by the clutch signal. The functionality of the driver is illustrated by the Simulink, Figure 6. The output from the PI controller ranges from -1 to 1 where 1 represents the maximum acceleration and -1 represents maximum braking. Three things that reflect a real driver are visible in the plot:

- (1) The driver can not press the brake and gas pedal simultaneously. This is implemented by the min and max selectors connected to the output of the PI Driver.
- (2) When the driver pushes the clutch down he also decreases the gas pedal. This is implemented by the multiplication on gas pedal output.
- (3) When a new gear is in place and the clutch is engaged then the information from the last gear is forgotten. This is implemented by resetting the integral part of the PI Driver.

##### 5.1 Driver tuning

The driver was tuned to a driving cycle using a simple manual method. When the P-part of the PI-controller is increased the error between the desired speed and actual speed decreases but both the engine and brake torques increase. The P-part was tuned first and a trade off was made between good following of the desired vehicle speed and reasonable control signals. Then the integral part

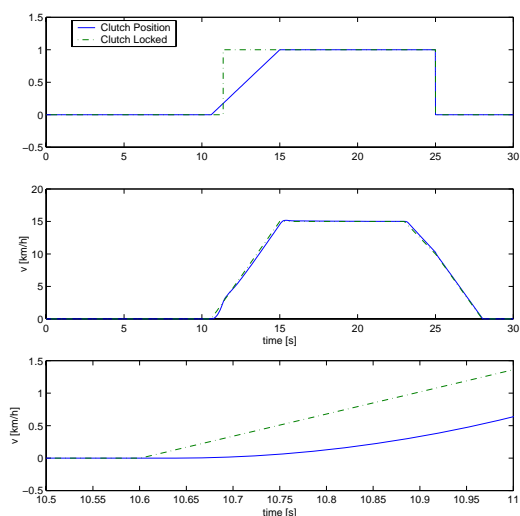

Fig. 7. Start and stop of vehicle showing that there is no chattering in the vehicle speed at start and stop.

was increased to yield zero stationary error within approximately one second.

## 6. SIMULATION RESULTS

The complete model is validated using two scenarios; First, the vehicle start from zero velocity which especially validates the rolling resistance model. Then the complete system is submitted to a complete European driving cycle.

### 6.1 Vehicle Start and Stop

A start and stop scenario is shown in Figure 7. The top plot shows the clutch information. The second plot shows the desired speed and the actual speed. The third plot shows and enlargement of the vehicle start, note that there is no chattering in the vehicle speed (solid line in the plot) when the vehicle starts to roll.

### 6.2 Complete Drive Cycle

A simulation of the complete European drive cycle is shown in Figure 8. As it can be seen the complete test cycle is successfully simulated. One thing that is interesting to note is that the engine speed over shoots at the gear changes when the vehicle is accelerating. This is due to the first order model of the engine dynamics in combination with the driver that does not have any prior knowledge of the driving cycle it is following and does not know of the upcoming gear change.

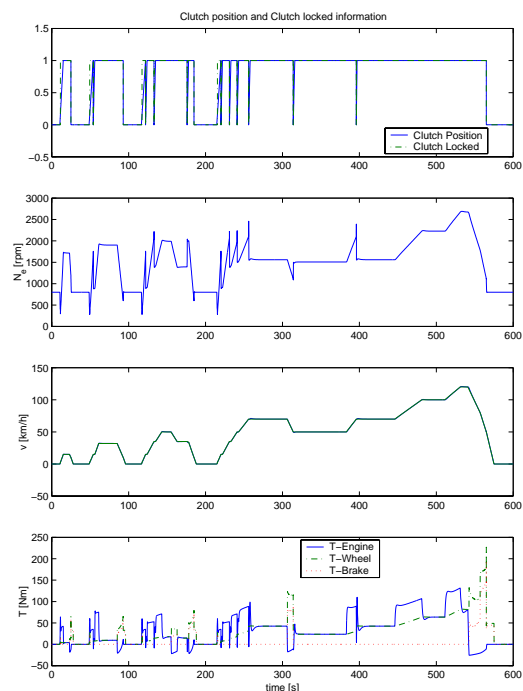

Fig. 8. Simulation results showing successful simulation of an European driving cycle.

## 7. CONCLUSIONS

A simple longitudinal vehicle model with variable clutch structure is described and tested. The model can handle the problems of simulating clutch lock and clutch release both when the vehicle is starting and during gear shifts. Special attention is also given the problem of simulating start and stop of a vehicle with rolling resistance at zero speed. The system is successfully simulated in Simulink and the validation is performed using three scenarios: one with only clutch lock and release, one with only start and stop of vehicle, and one full European driving cycle.

## 8. REFERENCES

- Gillespie, Thomas D. (1992). *Fundamentals of Vehicle Dynamics*. SAE International.
- Kiencke, Uwe and Lars Nielsen (2000). *Automotive Control Systems For Engine, Driveline, and Vehicle*. Springer-Verlag.
- Mat (1998). *Simulink-Stateflow Technical Examples: Using Simulink and Stateflow in Automotive Applications*.
- Mat (1999). *Simulink, Dynamic System Simulation for MATLAB – Using Simulink, Version 3*.
- Olsson, H, KJ Åström, C Canudas de Wit, M Gäfvert and P Lischinsky (1998). Friction models and friction compensation. *European Journal of Control* 4(3), p.176–195.